



特性

- 90~264Vac通用交流输入，内置PFC
- 可给铅酸电池、锂电池充电
- VR可调宽输出范围:
 - ▶ 充电电压可调(10.5~15.2V、21~30.4V、42~60.8V)
 - ▶ 充电电流可调(额定电流的50~100%)
- 2或3段式充电可通过DIP S.W选择
- 空载功耗 < 0.15W(AC S.W off)
- 风扇开/关控制(取决于内部温度)
- -30℃~+70℃宽工作温度
- 保护种类: 短路/过压/过温/电池反极性保护
- 符合UL/EN62368-1及EN60335-1/2-29双安规认证
- 前面板LED灯显示充电状态
- 3年长效保固

应用

- 无线电系统备份解决方案
- 电动车充电器
- 露营车、巴士、重型卡车、特种车辆
- 监测系统
- 便携式电动工具

全球交易品项识别码

MW搜寻: <http://www.meanwell.com.cn/serviceGTIN.aspx>

描述

NPB-360系列是一款360W充电器，适用于铅酸电池(加水式、胶体式、吸附玻璃纤维式)和锂电池(锂铁，锂锰)。本产品为I级电源(带FG)，配有IEC320-C14 AC标准插头和2/3段式充电控制。整系列提供输出电压为10.5VDC至60.8VDC的不同型号，可以满足各种类型电池的需求。

型号编码

NPB - 360 - 24 XLR

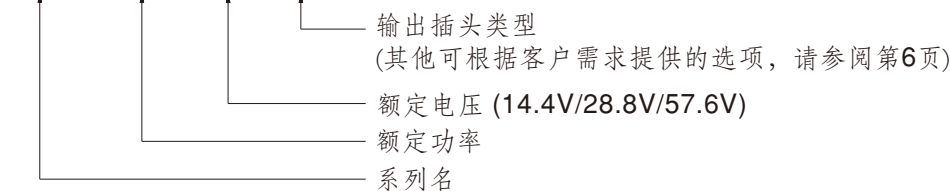

类型	输出插头	安规	备注
XLR	4 pin power pin		有货
AD1	Anderson Equivalent Connector	 (48V UL 认证与 TB 类型相同)	有货
TB	Terminal Block		有货



360W 宽范围输出小型化充电器

NPB-360 系列

电气规格

机型		NPB-360-12□	NPB-360-24□	NPB-360-48□	
		□ =XLR, AD1, TB			
输出	脉冲电压(Vboost)(默认)	14.4V	28.8V	57.6V	
	浮充电压(Vfloat)(默认)	13.8V	27.6V	55.2V	
	电压可调范围	10.5 ~ 15.2V	21 ~ 30.4V	42 ~ 60.8V	
	输出电流(Typ.) 备注5	20A	12A	6A	
	电流可调范围	50% ~ 100%			
	最大功率 备注3	304W	364.8W	364.8W	
	推荐电池容量 (AMP HOURS) 备注4	65 ~ 195AH	40 ~ 125AH	20 ~ 65AH	
输入	电压范围 备注5	90 ~ 264VAC 127 ~ 370VDC			
	频率范围	47 ~ 63Hz			
	功率因素(Typ.)	PF>0.98/115VAC, PF>0.95/230VAC (满载时)			
	效率(Typ.)	XLR	87%	91%	92%
		AD1	87%	91%	92%
		TB	88.5%	92%	92.5%
	交流电流(Typ.)	4.5A/115VAC 2.2A/230VAC			
浪涌电流(Typ.)	冷启动 50A/230VAC				
保护	短路 备注6	保护模式: 恒流限流, 5秒后充电器关机, 重启后恢复			
	过压	16 ~ 20V	32 ~ 40V	64 ~ 75V	
		保护模式: 关断并锁存输出电压, 重启后恢复			
	反极性	通过内部保险丝断开			
过温	打嗝模式, 温度下降后自动恢复				
功能	充电曲线	2或3段式充电可通过DIP S.W选择			
	风扇控制(Typ.)	内部 RTH3 ≥ 50°C 风扇开启, ≤ 45°C 风扇关断			
环境	工作温度	-30 ~ +70°C (请参考"减额曲线")			
	工作湿度	20 ~ 95% RH 无冷凝			
	储存温度、湿度	-40 ~ +85°C, 10 ~ 95% RH 无冷凝			
	温度系数	±0.05%/°C (0 ~ 45°C)			
耐振动	10 ~ 500Hz, 2G 10分钟/周期, X,Y,Z轴各60分钟				
安规和电磁兼容(备注7)	安全规范	CB IEC62368-1, IEC60335-1/2-29, Dekra BS EN/EN62368-1, BS EN/EN60335-1/2-29, UL62368-1, AS/NZS60335-1/2-29, EAC TP TC 004 认证通过			
	耐压	I/P-O/P:3KVAC I/P-FG:2KVAC O/P-FG:0.5KVAC			
	绝缘阻抗	I/P-O/P, I/P-FG, O/P-FG:100M Ohms / 500VDC / 25°C / 70% RH			
	电磁干扰	Parameter	Standard	Test Level / Note	
		Conducted	BS EN/EN55032 (CISPR32), BS EN/EN55014-1	Class B	
		Radiated	BS EN/EN55032 (CISPR32), BS EN/EN55014-1	Class B	
		Harmonic Current	BS EN/EN61000-3-2	Class A	
	Voltage Flicker	BS EN/EN61000-3-3	-----		
	电磁耐受	BS EN/EN55014-2, BS EN/EN55024, BS EN/EN55035			
		Parameter	Standard	Test Level / Note	
		ESD	BS EN/EN61000-4-2	Level 3, 8KV air ; Level 2, 4KV contact	
		Radiated	BS EN/EN61000-4-3	Level 2, 3V/m	
		EFT / Burst	BS EN/EN61000-4-4	Level 2, 1KV	
		Surge	BS EN/EN61000-4-5	Level 2, 1KV/Line-Line, Level 3, 2KV/Line-Earth	
		Conducted	BS EN/EN61000-4-6	Level 2, 3Vrms	
Magnetic Field		BS EN/EN61000-4-8	Level 1, 1A/m		
Voltage Dips and Interruptions		BS EN/EN61000-4-11	>95% dip 0.5 periods, 30% dip 25 periods, >95% interruptions 250 periods		
其他	MTBF	1324.7K hrs min. Telcordia TR/SR-332 (Bellcore); 173.9K hrs min. MIL-HDBK-217F (25°C)			
	尺寸	182.7*96*49mm (L*W*H)			
	包装	1.3Kg; 10pcs/ 14Kg / 1.13CUFT			
备注	<p>1. 充电器规格可能需依电池规格而修订, 请与电池供货商和明纬接洽细节。</p> <p>2. 如未特别说明, 所有规格参数均在输入为230VAC、额定负载、25°C环境温度下进行量测。</p> <p>3. 参考"减额曲线"。</p> <p>4. 这是明纬公司建议的范围, 关于最大充电电流限制请参考电池供应商的意见。</p> <p>5. 低输入电压情况下需要降额。请查看降额曲线了解更多详情。</p> <p>6. 此保护机制是针对充电器开机后发生短路的情况。</p> <p>7. 电源应视为一个独立的元件, 需结合终端设备进行电磁兼容相关确认。有关EMC测试操作指导, 请参阅"电源供应器EMI测试声明书"。(在明纬网站http://www.meanwell.cc)</p> <p>※ 产品免责声明: 详情请参阅 http://www.meanwell.cc/serviceDisclaimer.aspx</p>				

■ 方框图

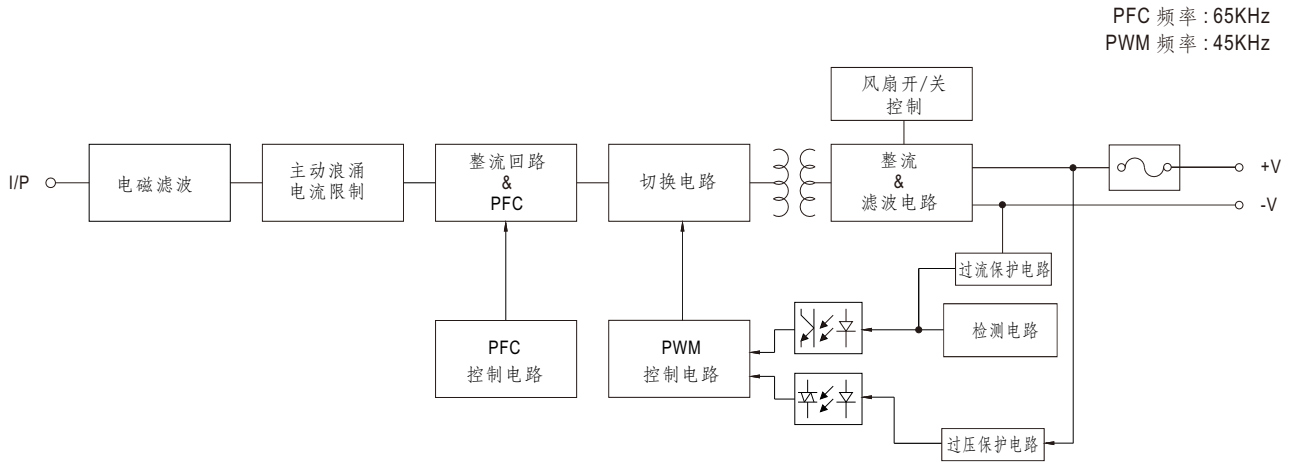

■ 减额曲线

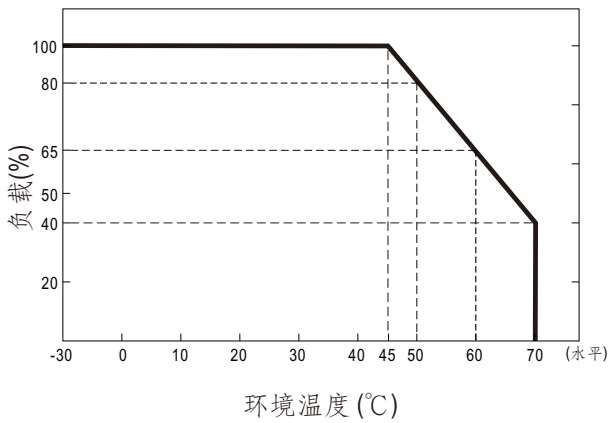

■ 静态特征曲线

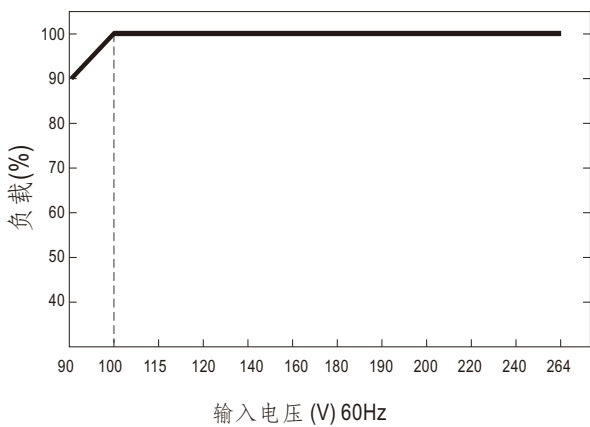

功能手册

1. 充电曲线

1-1 2 或 3 段式充电可通过 DIP S.W 选择

※ 本系列提供 2 或 3 段式充电曲线。(默认 3 段式)

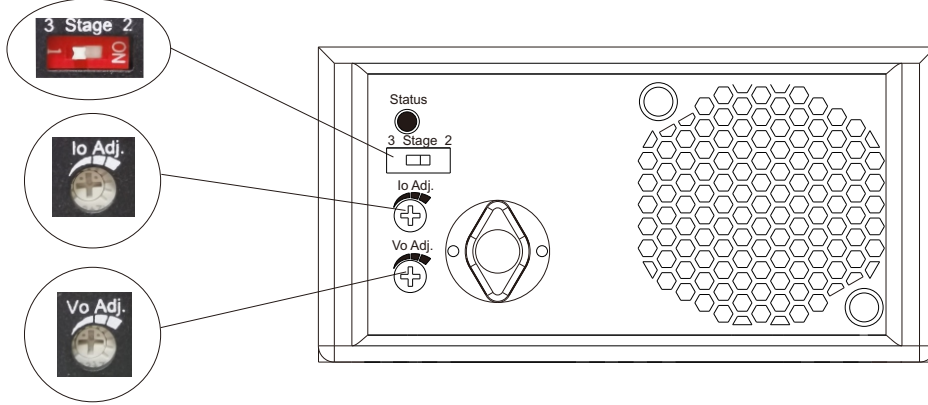

1-2 充电曲线可通过 DIP S.W 调节

◎ 2 段式充电曲线

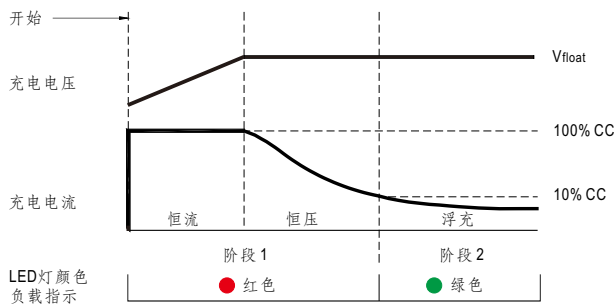

状态	NPB-360-12	NPB-360-24	NPB-360-48
恒流	20A	12A	6A
Vfloat	13.8V	27.6V	55.2V

◎ 3 段式充电曲线

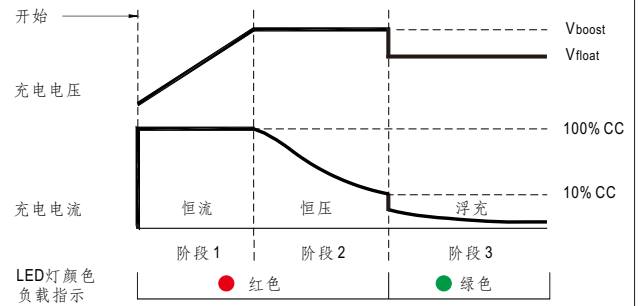

状态	NPB-360-12	NPB-360-24	NPB-360-48
恒流	20A	12A	6A
Vboost	14.4V	28.8V	57.6V
Vfloat	13.8V	27.6V	55.2V

◎ 2 段式充电曲线适用于锂电池(锂铁, 锂锰), 3 段式充电曲线适用于铅酸蓄电池(加水式、胶体式、吸附玻璃纤维式)。

2. 充电电压通过 VR 可调节

型号	NPB-360-12 <input type="checkbox"/>	NPB-360-24 <input type="checkbox"/>	NPB-360-48 <input type="checkbox"/>
输出电压可调范围	10.5~15.2V	21~30.4V	42~60.8V



3. 充电电流通过 VR 可调节

型号	NPB-360-12 <input type="checkbox"/>	NPB-360-24 <input type="checkbox"/>	NPB-360-48 <input type="checkbox"/>
输出电流可调范围	10~20A	6~12A	3~6A



4. 前面板 LED 指示灯及对应功能引脚信号

LED	描述
● 绿色	浮冲 (阶段3) 或充满
● 红色	充电 (阶段1 或 2)



■ 机构尺寸

◎ NPB-360-xx XLR/AD1
(电缆类型)

机壳编号:PS-120F 单位:mm

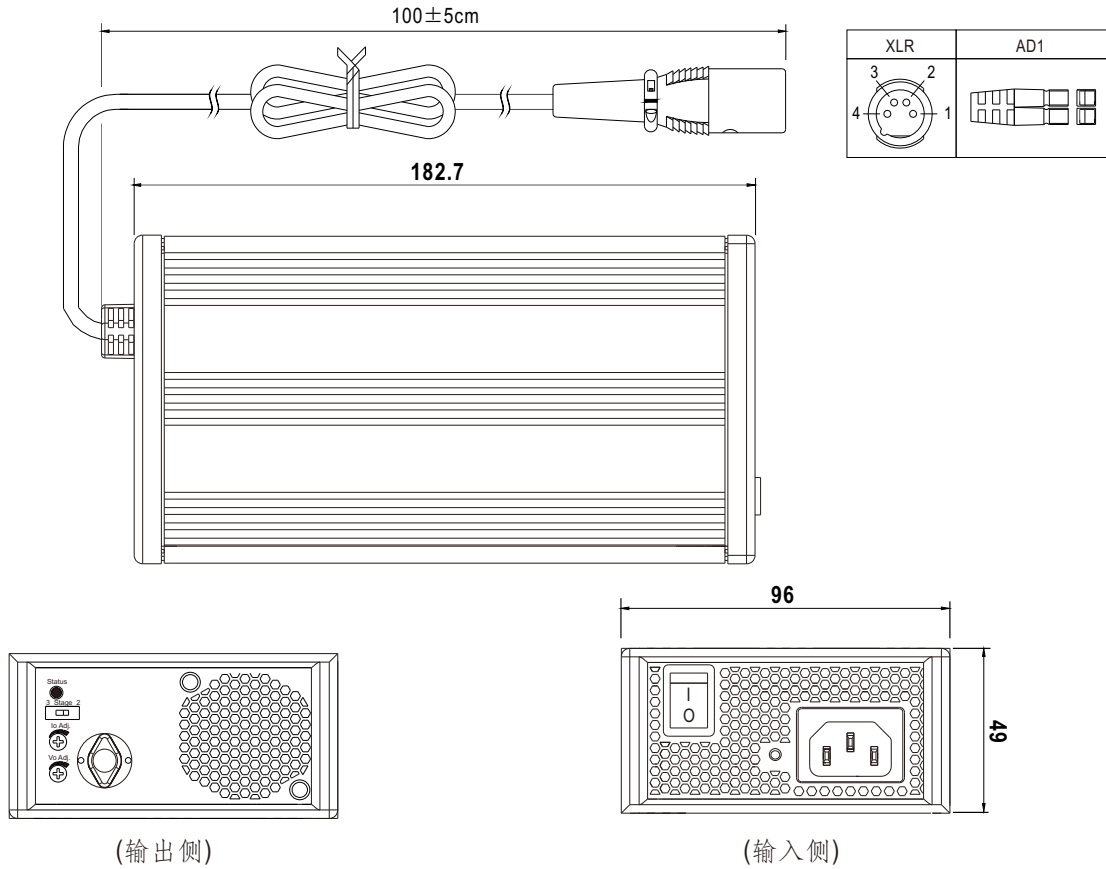

◎ NPB-360-xx TB
(端子台类型)

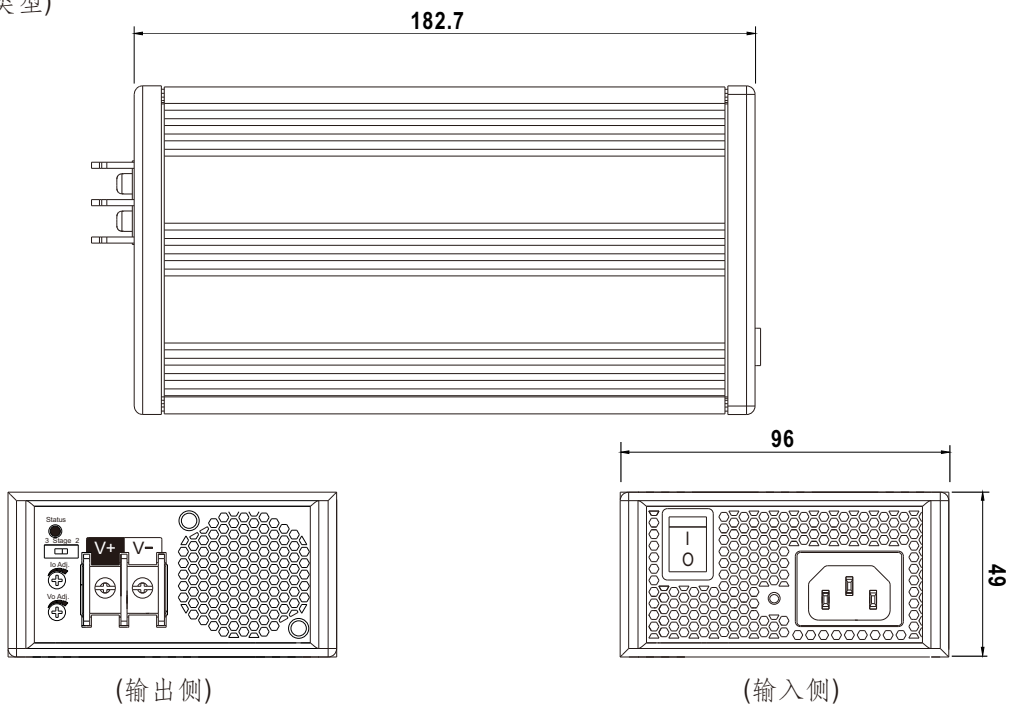

■ 配件列表

※ 固定支架 (选配配件, 需单独订购)

明纬订单编号	物件	数量
DGG2MHS012D		4pcs/单个充电器

■ 安装示意图

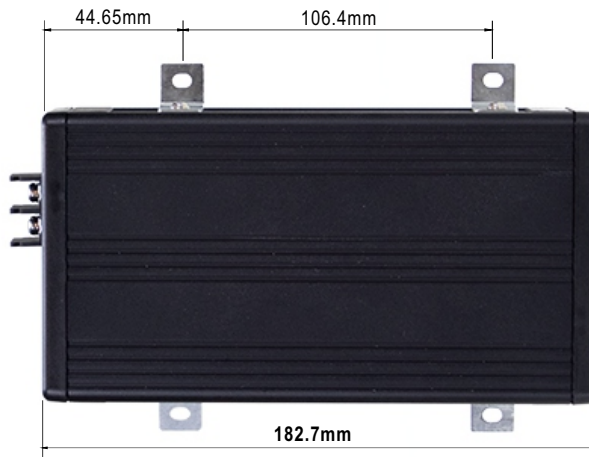
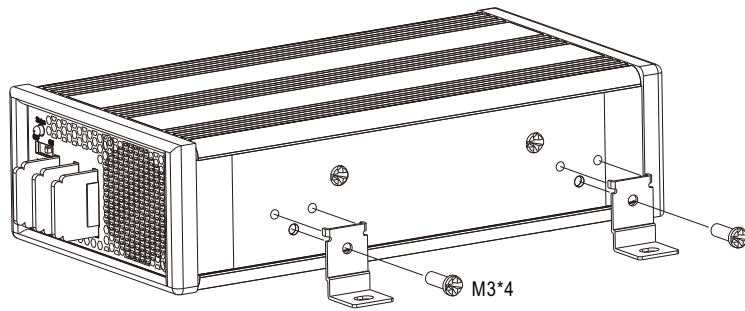

■ 插头定义

◎ 标准输出插头

4pin XLR
UNICABLE 89M103-4P 或同等级

3	2	引脚编号	输出
4	1		
		1,2	+V
		3,4	-V





AD1
外壳: Anderson 1327(红色), 1327G6(黑色)同等级品
接触头: Anderson 261G2 (45A) 同等级品

红色(+V)  黑色(-V)











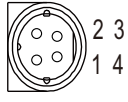
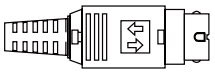

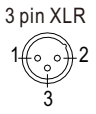
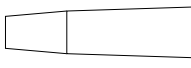
TB
DT-66-B11W-02 或同等级
额定: 300V 40A

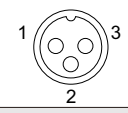
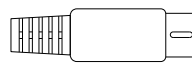
+V  -V

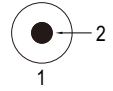
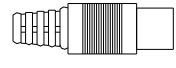

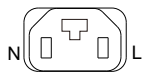
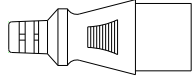
◎ 可选DC插头: (以下插头皆可订制)

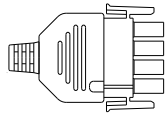
Min. DIN 4 Pin with Lock (male)	型号	引脚功能	
		引脚编号	输出(<7A)
   <p>KYCON KPPX-4P equivalent</p>	R7B	1	+Vo
		2	-Vo
		3	-Vo
		4	+Vo
DIN 3 Pin XLR	型号	引脚功能	
  	XLR3	1	+Vo
		2	+Vo
		3	-Vo
DIN 3 Pin	型号	引脚功能	
  	D3P	1	+Vo
		2	-Vo
		3	-Vo
DIN 2 Pin	型号	引脚功能	
  	D2P	1	-Vo
		2	+Vo
DIN 3 Pin	型号	引脚功能	
  	INL3	N	+Vo
		L	-Vo
AMP 1-480702-0 (6.35mm) equivalent	型号	引脚功能	
   <p>FG not connected to output connector</p>	C4P	1	+Vo
		2	+Vo
		3	-Vo
		4	-Vo

■ 安装手册

请查阅: <http://www.meanwell.com/manual.html>